







OWNER'S MANUAL

MMR™
MOSSBERG
MODERN RIFLE

SEMI-AUTOMATIC RIFLE
WITH DETACHABLE MAGAZINE

IMPORTANT "SAFETY WARNINGS" – NOTE THE SYMBOL

THESE SAFETY WARNINGS ARE FOR YOUR PROTECTION AS WELL AS THE SAFETY OF OTHERS. DISREGARDING INFORMATION IN THIS MANUAL MAY RESULT IN SERIOUS INJURY OR DEATH.

-  Be certain this owner's manual is available for reference and is kept with this firearm if transferred to another party. If this manual is lost or misplaced, contact the Product Service Center for a free replacement copy.
-  After performing any work on your firearm such as cleaning, adjustments, disassembly or installation of any accessory, the firearm should be re-checked for proper functioning before firing live ammunition.
-  Firearms are complex mechanisms. Any modification, alteration, or improper fitting of parts may result in a dangerous malfunction, damage to the firearm, and injury to the shooter and/or others nearby. The firearm's owner must accept full responsibility for the correct reassembly and functioning of the firearm after any disassembly or replacement of parts.
-  If you do not understand any of the material in this manual or have any questions, contact the Product Service Center or a qualified gunsmith.
-  Do not attempt to load, handle or use the firearm until you read and understand the information contained in its owner's manual. Before handling your firearm, you should learn how it operates and how to maintain it. This includes knowing its basic parts, how the manual safety and other safety features operate, how to safely open and close the action and how to safely load and unload ammunition from the firearm. Improper use and handling is dangerous and could cause serious injury or death to you or those around you. All users of the firearm must become thoroughly familiar with the instructions in this manual.

O.F. MOSSBERG & SONS, INC.

P.O. BOX 497 • 7 GRASSO AVENUE, NORTH HAVEN, CT 06473
PHONE (800) 363-3555
www.mossberg.com

Safety and safe firearms handling is everyone's responsibility.



As the owner of a firearm, you must undertake the full-time responsibility of safe firearms handling for your own safety and the safety of those around you:

- Keep all firearms and ammunition out of the reach of children.
- Store your firearms and ammunition separately.
- Never store a loaded firearm.
- Never leave a loaded firearm unattended.
- Never transport a loaded firearm in a vehicle.
- Unload your firearm when you have stopped shooting and when you have to climb a tree, fence, cross a slippery surface or have to transport it in a vehicle.
- Do not load your firearm before you are in a place where it is safe to shoot, and keep your finger off the trigger until you are on target and have decided to fire.
- Never shoot at water, rocks or any hard surfaces. Bullets may glance off such surfaces and cause injuries.
- Do not use alcohol or drugs before or while handling firearms.
- Do not touch the trigger while the safety selector lever is being engaged or disengaged.



Always point the muzzle of your firearm in a safe direction, regardless of whether the firearm is loaded or unloaded. You should become thoroughly familiar with the function and operation of this firearm and the instructions supplied with it.



Always treat every firearm as if it is loaded. Give your firearm to someone with the action open (bolt fully rearward), and the safety selector lever fully to the “ON” (SAFE) position, after you verify the firearm is unloaded. Insist on the same procedure when receiving a firearm from someone else. Learn the location of all the safety features of your firearm and how they operate.



Wear eye and ear protection when shooting. Shooting without proper ear protection can cause hearing damage. The use of eye protection during any type of shooting is important to protect your vision.



When using a firearm with mounted optics, maintain an adequate distance between the rear of the scope and your face at all times. Be certain the scope installation does not interfere with access to, or the proper functioning of the safety selector lever.



We specifically disclaim any responsibility for damage or injury whatsoever occurring in connection with, or as a result of, the use of faulty, or non-commercially manufactured, or remanufactured or hand-loaded (reloaded) ammunition. Additionally, we disclaim any responsibility for damage or injury which results from any modifications or changes that are not a part of the firearm as delivered from the factory.



Learn to clean your firearm thoroughly and make certain no oil, grease or other materials are blocking the barrel. Obstructions of any kind can cause damage to the firearm resulting in personal injury.

Practice proper firearm maintenance and safety. Make sure all exposed metal surfaces are coated with a thin film of oil, especially after being exposed to damp weather. (See the proper section of this manual for cleaning instructions.) Do not plug the barrel or store in a fabric-lined case, which will absorb lubricants from the firearm. Before using after storage, follow complete instructions stated in this manual for re-familiarization with the firearm. A thorough inspection and function test should be performed before going into the field. Have your firearm periodically checked by a qualified gunsmith.

A note about the warnings and information contained in this manual:

We strongly suggest that you check with your local licensed retailer or state police for additional information concerning firearms ownership, or hunting or target shooting rules that may be required by local law or regulation. Since such rules and regulations are subject to change, local authorities are in the best position to advise you on such matters.

TABLE OF CONTENTS

	Page
General Information and Mechanical Characteristics	4-6
Mechanical Safety	6
Opening the Action	7
Removing the Magazine	7
Loading the Firearm	8-9
A. Loading the Magazine	8
B. Loading the Magazine into the Firearm	8-9
C. Unloading the Firearm	9
D. Unloading the Magazine	9
Firing	9-11
Disassembly	11-15
Cleaning and Lubrication	15-17
Assembly and Final Lubrication	17-19
Function Testing	19-20
Sight Adjustments (Tactical Model)	20-21
Adjustable Buttstock (Tactical Model)	21
Service Instructions	22
Warranty Information	23
Parts List For Hunter Models	24
Exploded View For Hunter Models	25
Parts List For Tactical Models	26
Exploded View For Tactical Models	27
Notes	28-31
Basic Rules of Safe Firearms Handling	Back Cover

GENERAL INFORMATION AND MECHANICAL CHARACTERISTICS

The MMR™ is designed to operate with the ammunition caliber inscribed on the barrel and as shown below:

5.56mm NATO can also fire .223 Rem rifle cartridges

7.62mm NATO can also fire .308 Win rifle cartridges

When the firearm leaves the factory, its metal parts are protected by a coat of very adherent oil. This coating, especially inside of the barrel, must be removed before using the firearm. The oil on the outside surfaces should also be removed when the packing box has been opened because the oil is very sticky and it easily retains dust and other solid impurities from the air.



WARNING

Because this firearm can be used as a single shot, it will fire whether or not a magazine is in the firearm if a cartridge is chambered.

FIREARM WILL FIRE WITH MAGAZINE OUT.



Be sure the cam pin is installed in the bolt carrier assembly. The firearm will fire without the cam pin and the firearm will explode, causing damage to your firearm and may result in serious personal injury to the shooter and/or others nearby.



Check your firearm for proper functioning before loading or firing live ammunition.



This firearm could chamber a cartridge if dropped or jarred with a loaded magazine in place and the bolt carrier assembly locked to the rear or in its forward position.



When firing a large number of cartridges in a short period of time, the barrel of the firearm will become extremely hot. If this firearm stops firing with a live cartridge in the chamber of a very hot barrel, remove the magazine and chambered cartridge immediately and allow the firearm to cool. This firearm could fire just from the heat of the barrel.

The MMR™ is designed to fire semi-automatically. A single cartridge will fire each time the trigger is pulled. Finger pressure must be relieved from the trigger before an additional shot can be fired.

The MMR™ handguards are free float tubes. Standard AR-15 / M16 type magazines of various capacities will function in the 5.56mm NATO MMR™. Use Mossberg factory magazines or aftermarket magazines of the same style in the 7.62mm NATO MMR™.

GENERAL INFORMATION AND MECHANICAL CHARACTERISTICS CONT.



Fig. 1 – MMR 5.56 Hunter (Right Side)

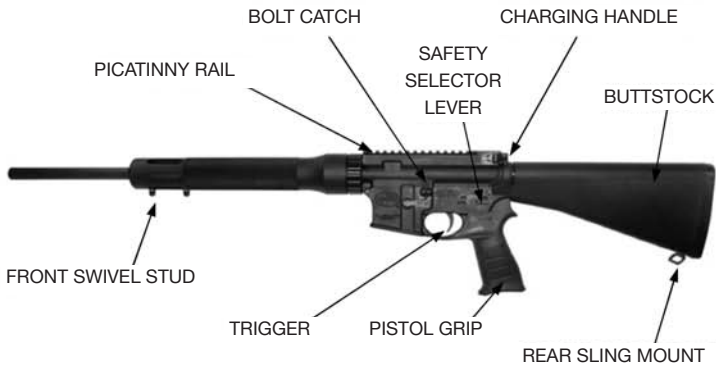

Fig. 2 – MMR 5.56 Hunter (Left Side)



Fig. 3 – MMR 5.56 Tactical w/ optional sights (Right Side)



Fig. 4 – MMR 5.56 Tactical w/ optional sights (Left Side)

GENERAL INFORMATION AND MECHANICAL CHARACTERISTICS CONT.



Fig. 5 – MMR 7.62 Hunter (Right Side)



Fig. 6 – MMR 7.62 Hunter (Left Side)

MECHANICAL SAFETY

The safety selector lever is located on the left side of the receiver above the trigger and must be manually rotated to the desired position by the shooter.



Remember, a firearm's manual safety is a mechanical device which can never replace safe firearm handling practices.



Never rely on any mechanical mechanism or safety device to prevent the dangers of careless handling or pointing a firearm in an unsafe direction.

To put the manual safety in the “ON” (SAFE) position, the safety selector lever must be rotated fully to the horizontal position (Fig. 7). The safety selector lever will now point toward the “SAFE” stamping on the receiver. The stamp is a training aid used only to show the direction of the “ON” (SAFE) position and should not be used as an indicator that the manual safety is “ON” or “OFF.” Rotating the safety selector lever fully to the vertical position will put the manual safety in the “OFF” (FIRE) position (Fig. 8). The safety does not rotate to the “ON” (SAFE) position if the firearm is not cocked.



Fig. 7



Fig. 8

OPENING THE ACTION

The bolt catch is located on the left side of the receiver above the magazine well (Fig. 2).

The bolt catch allows the action to be held open for inspection of the chamber and action or unloading without pulling the trigger. The action may be manually opened by pulling the charging handle out and pressing on the bottom of the bolt catch until the action catches and stays open (Fig. 9).

Note: The action will lock open when an empty magazine is installed, and the action is cycled by pulling the charging handle rearward.



Fig. 9

REMOVING THE MAGAZINE

 **WARNING**

Because this firearm can be used as a single shot, it will fire whether or not a magazine is in the firearm if a cartridge is chambered.

FIREARM WILL FIRE WITH MAGAZINE OUT.



Removal of the magazine will not unload the firearm! After you remove the magazine always visually and physically inspect the chamber and receiver to ensure the firearm is completely unloaded!

This firearm is equipped with a removable magazine. The magazine can be removed with the action in the open or closed position. Remove the magazine by pressing on the magazine release button (Fig. 10). Most magazines will fall freely from their seat. Familiarize yourself with the firearm by installing and removing an **unloaded** magazine and by learning to keep the action in the **open** position.



Fig. 10

LOADING THE FIREARM



Before loading, rotate the safety selector lever fully to the horizontal position to place it in the “ON” (SAFE) position.



Before loading, visually and physically inspect the chamber and bore of the barrel for any obstruction, excessive oil or grease. (The chamber is the rear portion of the barrel which will contain the cartridge.) Obstructions of any kind can cause damage to the firearm and may result in serious personal injury to the shooter and/or others nearby.



During loading never allow fingers or any objects to contact the trigger. Keep the muzzle pointed in a safe direction at all times.



Do not load firearm until ready for use! Unload firearm when shooting has been completed! The safety selector lever should always be in the “ON” (SAFE) position whether the firearm is loaded or not.



Check to be certain that the correct ammunition has been selected for use. Ensure it is the same caliber and type of cartridge as designated on the left side of the barrel.



This firearm is capable of firing a chambered cartridge with the magazine empty, without the magazine inserted, or if the magazine is dislodged from its seat.

A. LOADING THE MAGAZINE

To load the magazine, remove the magazine by pressing the magazine release button. Hold the magazine in one hand and insert one cartridge at a time (Fig. 11), pressing against the magazine follower and rearwards until the magazine is full, or until the desired number of cartridges has been loaded.



Fig. 11

B. LOADING THE MAGAZINE INTO THE FIREARM

Insert a loaded magazine into the firearm by sliding the magazine up into the magazine well until it is retained by the magazine catch (Fig. 12). Pull on the magazine to make sure the magazine is firmly seated (Fig. 13). Press the upper portion of the bolt catch to close the action and load a cartridge into the chamber (Fig. 14).



The firearm is ready for firing as soon as the safety selector lever is rotated fully to the “OFF” (FIRE) position.



Fig. 12



Fig. 13



Fig. 14

To minimize the risk of unintended firing, leave the chamber empty and the safety selector lever in the “ON” (SAFE) position until you are on target and have decided to fire. Keep the muzzle pointed in a safe direction at all times and your fingers and any other objects away from the trigger.

C. UNLOADING THE FIREARM

 Rotate the safety selector lever fully to the “ON” (SAFE) position. During unloading, never allow fingers or any other object to contact the trigger. **KEEP THE MUZZLE POINTED IN A SAFE DIRECTION AT ALL TIMES.**

Remove the magazine by pressing the magazine release button. Pull the charging handle back while pressing on the lower portion of the bolt catch until the action catches and stays open. This will extract a loaded cartridge from the chamber.

 After unloading always visually and physically inspect the chamber, receiver and magazine to make sure that all of the cartridges have been removed.

D. UNLOADING THE MAGAZINE

Hold the magazine in one hand bottom down and front end forward. Push the cartridge forward and allow the nose of the cartridge to rise slightly upward until it is released from the magazine. Repeat until magazine is unloaded.

FIRING

 Discharging firearms in poorly ventilated areas, cleaning firearms, or handling ammunition may result in exposure to lead and/or other substances known to cause birth defects, reproductive harm, and/or other serious physical injury. Have adequate ventilation at all times. Wash hands thoroughly after exposure.

With the firearm pointed in a safe direction and held in the proper firing position, rotate the safety selector lever fully to the vertical “OFF” (FIRE) position (Fig. 15). Pulling the trigger through its full travel to the rear will fire the firearm.

After the firearm is fired the action will be cycled by the gas system and automatically load the next cartridge. The trigger must be fully released before the firearm will be ready to fire again.





Fig. 15

If there is a pause in firing, rotate the safety selector lever fully to the “ON” (SAFE) position. If so equipped, the ejection port cover will automatically open when the firearm is fired again or when the bolt is manually opened (Fig. 16).



Fig. 16

-  Should a cartridge fail to fire after pulling the trigger, keep the firearm pointed in a safe direction in case of a hangfire. Wait a few moments then pull the charging handle to the rear to extract and eject the misfired cartridge and segregate from other ammunition. Do not attempt to refire a misfired cartridge.
-  If at any time during firing, the sound of any given cartridge is noticeably louder or softer than previous cartridges fired, STOP! Do not load or fire additional cartridges until you have safely unloaded your firearm and inspected it for possible damage or obstruction in the chamber or bore. (The bore is the inside surface of the barrel.) Firing the firearm with a bore obstruction can cause damage to the firearm and may result in serious personal injury to the shooter and/or others nearby.
-  When firing a large number of cartridges in a short period of time, the barrel of the firearm will become extremely hot. If this firearm stops firing with a live cartridge in the chamber of a very hot barrel, remove the magazine and chambered cartridge immediately and allow the firearm to cool. This firearm could fire just from the heat of the barrel.

Each brand and type of ammunition can produce different accuracy results. It is best to try as many brands and types of ammunition as possible to determine which performs best in your firearm.

DISASSEMBLY



Rotate the safety selector lever fully to the “ON” (SAFE) position. Remove the magazine and visually and physically check the chamber and receiver to be certain the firearm is unloaded before disassembling the firearm. Wear eye protection during disassembly and cleaning.

Depress the large upper portion of the bolt catch to close the action. Use a non-marring punch to push out the takedown and pivot pins (Figs. 17 & 18). (Detents will keep the pins from falling out of the receiver.)



Fig. 17



Fig. 18

The upper and lower halves of the receiver will now come apart (Fig. 19).



Fig. 19

Turn the upper receiver over and pull the charging handle out to remove the bolt carrier assembly (Figs. 20 & 21) then pull the charging handle while lifting to remove it (Fig. 22).



Fig. 20



Fig. 21



Fig. 22

Use a punch to remove the firing pin retaining pin (Fig. 23) by pushing through the firing pin retaining pin hole on the right side of the bolt carrier assembly (Fig. 24). Remove the firing pin (Fig. 25).



Fig. 23



Fig. 24

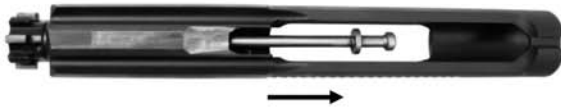

Fig. 25

Push the bolt subassembly in (Fig. 26) and twist the cam pin a quarter turn and lift to remove the cam pin on the 5.56 model (Fig. 27). Lift the cam pin to remove the cam pin on the 7.62 model.



Fig. 26



When reassembling the firearm, be sure the cam pin is installed in the bolt carrier assembly. The firearm will fire without the cam pin and the firearm will explode, causing damage to your firearm and may result in serious personal injury to the shooter and/or others nearby.



Fig. 27

Pull the bolt subassembly out through the front of the bolt carrier (Fig. 28).



Fig. 28

Use a punch to drive out the extractor pin and remove the extractor (Fig. 29), but be careful not to lose the rubber seal on the extractor spring (Fig. 30).



Fig. 29

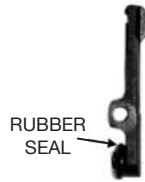

Fig. 30

Use a punch to depress the buffer retainer (Fig. 31) and remove the buffer assembly and action spring (Fig. 32). The hammer must be pressed down into the cocked position to remove the buffer assembly.



Fig. 31



Fig. 32

Use a punch to lift the floorplate of the magazine (Fig. 33) and slide it rearwards (Fig. 34) to access the magazine spring and follower (See Fig. 35 on page 15).



Fig. 33



Fig. 34



Fig. 35

Further disassembly of the firearm should be performed by a qualified gunsmith only.

CLEANING AND LUBRICATION

With proper maintenance and care, your firearm will provide you with years of dependable service. Your firearm should be inspected and cleaned periodically to insure that it remains in good condition. Clean and lubricate your firearm as soon as possible after use. This is especially important if your firearm has been exposed to moisture. For maximum performance and continued satisfaction with your firearm, periodic cleaning and lubrication are essential. Wear eye protection during cleaning.

Use the instructions and equipment provided with a quality firearm cleaning kit.

All metal parts should be cleaned with firearm solvent and lightly lubricated with firearm oil. Over-lubrication should be avoided. Use only lubricants specifically designed for firearms. Avoid the use of abrasives which may damage the metal finish.

If the firearm is to be stored for a long period of time it should be thoroughly cleaned and oiled. Do not plug the barrel or store in a fabric lined case that will absorb lubricant from the firearm.

Using a cleaning patch and cleaning rod, wet the bore and chamber with cleaning solvent. Use a bore brush and a chamber brush to remove powder residue and fouling from the bore and chamber. Follow with cleaning patches until the bore and chamber are clean (Fig. 36). If the firearm is to be stored, pass a lightly oiled patch through the bore to provide a protective coating. Wipe out the inside surfaces of the receiver with a solvent soaked cleaning patch. Dry the inside surfaces with clean patches. Using a cleaning patch, apply a light coat of oil to the inside surfaces of the upper receiver.



Fig. 36

Apply oil to the ejector (Figs. 37 and 38).



Fig. 37



Fig. 38

Clean the bolt carrier key with a pipe cleaner (Fig. 39). Clean the bolt hole and cam pin slot with patches and a soft nylon brush. Dry the bolt hole and cam pin slot with clean patches.



Fig. 39

Remove powder residue and carbon from all external surfaces of the bolt using solvent-soaked cleaning patches and a brass brush. Clean the firing pin hole with a pipe cleaner. Apply solvent to the gas rings until they are able to move freely. Wipe all the remaining solvent off of the bolt using clean patches. Inspect the bolt (Fig. 40) and bolt face (Fig. 41), firing pin (Fig. 42), cam pin (Fig. 43), firing pin retaining pin (Fig. 44), extractor (Fig. 45), and bolt carrier (Fig. 46) for cracks, fractures, chips and wear.

! **Should you detect any cracks, fractures, chips, or excessive wear, do not use your firearm until you have contacted the Product Service Center or a qualified gunsmith. Using broken or worn parts may result in a dangerous malfunction, damage to the firearm, and serious personal injury to the shooter and/or others nearby.**



Fig. 40



Fig. 41



Fig. 42



Fig. 43



Fig. 44



Fig. 45



Fig. 46



Make sure the barrel and receiver are free of obstructions and excessive lubricant after cleaning. Be sure not to leave cleaning patches or excessive oil or grease in the bore as they can create dangerous obstructions. Obstructions of any kind can cause damage to the firearm and may result in serious personal injury to the shooter and/or others nearby.



Camouflage firearms: Caution should be exercised to avoid exposure of camouflage patterns to solvents or insect repellants.

ASSEMBLY AND FINAL LUBRICATION

Wipe off any powder residue from the action spring and buffer assembly. Insert the action spring and buffer assembly into the receiver extension on the lower receiver. Place the extractor in its slot on the bolt and insert the extractor pin. Rotate the gas rings on the bolt so that the gaps are equally spaced (Fig. 47).



Fig. 47



Be sure the cam pin is installed in the bolt carrier assembly. The firearm will fire without the cam pin and the firearm will explode, causing damage to your firearm and may result in serious personal injury to the shooter and/or others nearby.

Lightly lubricate the bolt and cam pin. Insert the bolt into the carrier with the extractor on the right side as shown (Fig. 48) and reinsert the cam pin.



Fig. 48

Insert the firing pin (Fig. 49), and then pull the bolt subassembly forward until it stops (Fig. 50).



Fig. 49



Fig. 50

Insert the firing pin retaining pin into its hole on the side of the bolt carrier assembly until the pin is fully seated (Fig. 51).



Fig. 51

Insert the charging handle into the upper receiver with the groove open upwards until the tabs on either side of the handle fall into their notches in the upper receiver (See Fig. 52 on page 19).



Fig. 52

Apply a light coat of oil to all surfaces of the bolt carrier assembly. Apply one drop of oil in each hole on the right side of the bolt carrier and in the open end of the bolt carrier key. Pull the bolt subassembly forward until it stops. Insert the bolt carrier assembly into the upper receiver with the bolt carrier key in the charging handle groove (Fig. 53).



Fig. 53

Slide the bolt carrier assembly and charging handle into the upper receiver until they lock into the receiver (the back of the carrier will be flush with the back of the upper receiver and the charging handle will be locked forward). Align the pivot and takedown pins and with their respective holes in the upper receiver and push pins into the holes until fully seated (Fig. 54).



Fig. 54

FUNCTION TESTING



Check your firearm for proper functioning before loading or firing live ammunition.



Rotate the safety selector lever fully to the “ON” (SAFE) position.



Be sure the firearm is completely unloaded by opening the action, removing the magazine and visually and physically inspecting the chamber and receiver. Keep the firearm pointed in a safe direction at all times.

Open and close the action several times to check for free movement of the action assembly.

Close the action and leave the safety selector lever in the “ON” (SAFE) position. Pull the trigger fully rearward. The hammer should not release.

Remove your finger from the trigger. Rotate the safety selector lever fully to the “OFF” (FIRE) position. The hammer should not release.

Leave the safety selector lever in the “OFF” (FIRE) position. Make certain the firearm is pointed in a safe direction. Pull the trigger fully rearward. **THE HAMMER SHOULD RELEASE.**

When you have completed the function testing, open the action and rotate the safety selector lever fully to the “ON” (SAFE) position.



IF YOUR FIREARM DOES NOT PERFORM AS DESCRIBED IN ANY OF THE PREVIOUS STEPS, CONTACT THE FACTORY AUTHORIZED PRODUCT SERVICE CENTER IMMEDIATELY. DO NOT ATTEMPT TO USE THE FIREARM.



Firearms are complex mechanisms. Any modification, alteration, or improper fitting of parts may result in a dangerous malfunction, damage to the firearm, and injury to the shooter and/or others nearby. The firearm’s owner must accept full responsibility for the correct reassembly and functioning of the firearm after any disassembly or replacement of parts.



PERIODICALLY CHECK THAT THE MUZZLE BRAKE (IF SO EQUIPPED) IS TIGHTENED FIRMLY ONTO THE BARREL.

SIGHT ADJUSTMENTS (OPTIONAL ON TACTICAL MODELS)=====



Before making any sight adjustments, open the action, remove the magazine and visually and physically inspect the chamber and inside the receiver to be certain the firearm is unloaded. Rotate the safety selector lever fully to the “ON” (SAFE) position and keep the muzzle pointed in a safe direction.

Elevation adjustment: To raise the point of impact, lower the front sight by depressing the detent and turning the front sight clockwise. To lower the point of impact, raise the front sight by depressing the detent and turning the front sight counter-clockwise.



Fig. 55

Windage adjustment: To move the point of impact to the right, turn the side adjustment knob clockwise into the “R”. To move the point of impact to the left, turn the side adjustment knob counter-clockwise away from the “R”.

REAR SIGHT APERTURE

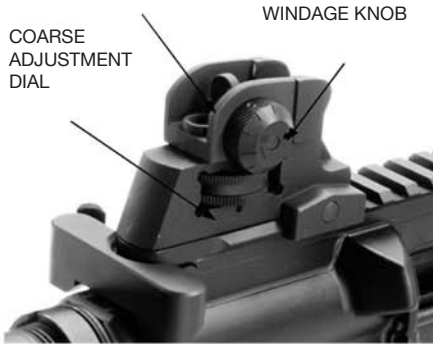



Fig. 56

Long and Short Range Apertures: The rear sight has two apertures. The large aperture is for short range shooting while the small aperture is for long range shooting. The apertures are changed by pushing the aperture piece forward or backward.

Coarse adjustment: The rear sight is equipped with a coarse adjustment dial located beneath the aperture. With the dial all the way down the sights are set for 0-300 meters. With the smaller aperture the sights can be adjusted for 300, 400, 500, 600, or 700 meters using the scale on the coarse adjustment dial.

ADJUSTABLE BUTTSTOCK (OPTIONAL ON TACTICAL MODELS) =====

 Before making any buttstock adjustments, open the action, remove the magazine and visually and physically inspect the chamber and inside the receiver to be certain the firearm is unloaded. Rotate the safety selector lever fully to the “ON” (SAFE) position and keep the muzzle pointed in a safe direction.

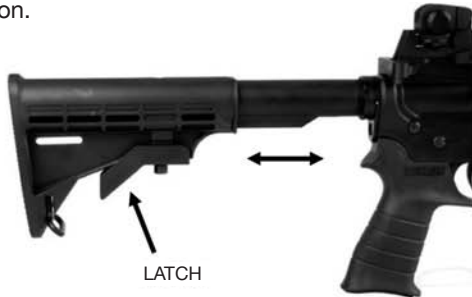



Fig. 57

The adjustable buttstock has 6 positions to adjust length of pull. To adjust length of pull, squeeze latch and slide buttstock in or out to desired position. Release latch and push inward on rear of buttstock until the buttstock locks into place. Tap or push on rear of buttstock to verify buttstock is locked into place.

 To avoid damage to the buttstock and to prevent possible personal injury, before firing live ammunition verify the buttstock is locked into place.

SERVICE INSTRUCTIONS

Should your firearm or any component of your firearm require service, ship your entire firearm (please do not send components only), via your chosen carrier, postage paid (we do not accept C.O.D. shipments), following these instructions:



- **Make absolutely certain your firearm is unloaded.**
- **Do not send ammunition with your firearm.**
- Remove all accessories from your firearm such as scopes, slings, mounts, etc.
- Ship your firearm in a suitable container, packaging it securely to prevent parts from shifting and/or harm during shipping.
- Include a note with a clear description of the service you wish us to perform, your complete return shipping address (no P.O. boxes please), your daytime telephone number and your e-mail address (if available). It is advisable to place your correspondence inside your shipping container when shipping.

SHIPPING ADDRESS

Product Service Center
Maverick Arms, Inc.
1001 Industrial Blvd.
Eagle Pass, TX 78853

If you have any service related questions, please contact the Product Service Center at (830) 773-9007 or service@mossberg.com

TO ORDER PARTS

To order parts from the Product Service Center, you can fax, phone, mail, or e-mail your order to one of the below numbers/addresses.

Fax Number: (830) 773-5893
Phone Number: (830) 773-9007
E-mail Address: service@mossberg.com
Mailing Address: Product Service Center
Maverick Arms, Inc.
1001 Industrial Blvd.
Eagle Pass, TX 78853
Attn: Order Department

Please provide your name, address, city, state, zip, your daytime phone number and e-mail (if available). The Product Service Center will need the Model #, Serial #, Gauge/Caliber, Finish, Item #, and Part Name. There is a \$7.50 (U.S.) minimum parts order charge. Most major credit cards, money orders, and bank drafts are accepted.

Service outside of the U.S.A.

For Mossberg firearm parts and service requirements outside of the United States, customers are requested to contact the closest Mossberg stocking dealer/distributor.

MOSSBERG® WARRANTY

MOSSBERG MODERN RIFLE

TWO (2) YEAR LIMITED WARRANTY

Limited Warranty: O.F. Mossberg & Sons, Inc. (“Mossberg”) warrants to you, the original retail purchaser of a new Mossberg Modern Rifle (the “Mossberg firearm”), that the Mossberg firearm will be free of defects in material or manufacture for a period of two (2) year from the date of your purchase of the new Mossberg firearm (the “Warranty Period”) in the United States or Canada. This is the only express warranty on the Mossberg firearm. MOSSBERG MAKES NO OTHER WARRANTIES OF ANY KIND OR CONDITIONS, INCLUDING, BUT NOT LIMITED TO ANY IMPLIED WARRANTY OF MERCHANTABILITY OR FITNESS FOR A PARTICULAR PURPOSE. This Limited Warranty gives you specific legal rights, and you may have other rights that vary from State to State.

Purchaser’s Remedy: During the Warranty Period, Mossberg will, at its sole option, (1) repair the Mossberg firearm or any part thereof that, upon examination and testing by Mossberg, does not conform to the Limited Warranty without charge to you for parts or labor, or (2) replace the Mossberg firearm with a new or similar model. THIS REMEDY SHALL BE YOUR EXCLUSIVE AND SOLE REMEDY FOR ANY BREACH OF WARRANTY. MOSSBERG SHALL NOT BE RESPONSIBLE FOR ANY OTHER EXPENSES, LOSSES OR INCONVENIENCE THAT YOU MAY SUSTAIN AS A RESULT OF THE PURCHASE, USE, MALFUNCTION OR DEFECTIVE CONDITION OF THE MOSSBERG FIREARM. Mossberg reserves the right to inspect, examine and/or test the Mossberg firearm to assess any claim made under the Limited Warranty.

EXCLUSIONS: THIS WARRANTY DOES NOT COVER THE COSMETIC APPEARANCE OF THE MOSSBERG FIREARM OR ANY DAMAGE CAUSED BY:

- (1) NORMAL WEAR AND TEAR;
- (2) FAILURE TO PERFORM PROPER CARE AND MAINTENANCE;
- (3) ACCIDENTS, ABUSE OR NEGLIGENCE;
- (4) BARREL OR BORE OBSTRUCTIONS;
- (5) FAILURE TO FOLLOW THE INSTRUCTIONS AND WARNINGS THAT ACCOMPANY THE MOSSBERG FIREARM; OR
- (6) THE USE OF DEFECTIVE, NON-SAAMI STANDARD, REMANUFACTURED, HANDLOADED, AND/OR RELOADED AMMUNITION.

IN ADDITION, ANY UNAUTHORIZED REPAIRS, ALTERATIONS OR MODIFICATIONS TO THE MOSSBERG FIREARM WILL AUTOMATICALLY VOID THE LIMITED WARRANTY.

LIMITATION OF DAMAGES: EXCEPT WHERE PROHIBITED BY LAW, MOSSBERG WILL NOT BE LIABLE FOR ANY LOSS OR DAMAGE WHATSOEVER ARISING FROM THE USE OF THIS MOSSBERG FIREARM, WHETHER DIRECT, INDIRECT, SPECIAL, INCIDENTAL, CONSEQUENTIAL OR PUNITIVE, REGARDLESS OF THE LEGAL THEORY ASSERTED, INCLUDING CONTRACT, WARRANTY, NEGLIGENCE, OR STRICT LIABILITY. SOME JURISDICTIONS DO NOT ALLOW LIMITATIONS ON HOW LONG AN IMPLIED WARRANTY LASTS, OR THE EXCLUSION OF INCIDENTAL OR CONSEQUENTIAL DAMAGES, SO THE ABOVE LIMITATIONS MAY NOT APPLY TO YOU.

Warranty Service: To obtain service under this Limited Warranty, you must follow the instructions found in the “Service Instructions” section of the Owner’s Manual and return the Mossberg firearm to the authorized Product Service Center. You are responsible for all shipping costs to the Product Service Center. Mossberg will not accept COD shipments of any Mossberg firearm for service. After repair or replacement, the Mossberg firearm or a similar model will be returned to you, return postage paid by Mossberg. If we replace the Mossberg firearm, we will keep the firearm that you returned to Mossberg.

Modification of Warranty: No agent, representative, distributor, or authorized dealer of Mossberg firearms has any authority to modify the terms or conditions of the Limited Warranty in any way. The Limited Warranty may only be modified in writing by an authorized officer of Mossberg.

THIS LIMITED WARRANTY IS EFFECTIVE SEPTEMBER 1, 2011.

Parts List: Hunter Models			
Item No.	Description	Item No.	Description
1*	Lower Receiver	27	Hammer Spring
2	Trigger	28	Hammer Pin
3	Trigger Pin	29*	Bolt Carrier with Bolt Carrier Key
4	Trigger Spring	30	Firing Pin
5	Disconnecter	31	Firing Pin Retaining Pin
6	Disconnecter Spring	32	Cam Pin
7	Safety Selector Lever	33*	Bolt with Gas Rings
8	Safety Detent	34	Extractor Assembly
9	Safety Detent Spring	35	Extractor Pin
10	Takedown Pin	36	Ejector
11	Pivot Pin	37	Ejector Pin
12	Takedown/Pivot Pin Detents	38	Ejector Spring
13	Takedown/Pivot Pin Detent Springs	39	Charging Handle
14	Pistol Grip	40	Receiver Extension
15	Grip Screw	41	Buffer Assembly
16	Grip Lockwasher	42	Action Spring
17	Grip Cap	43	Buttstock
18	Trigger Guard Screw	44	Buttcap Screw
19	Magazine Catch	45	Buttcap Spacer
20	Magazine Release Button	46	Buffer Retainer
21	Magazine Release Button Spring	47	Buffer Retainer Spring
22	Bolt Catch	48*	Upper Receiver Assembly
23	Bolt Catch Pin	49	Handguard
24	Bolt Catch Plunger	50	Magazine
25	Bolt Catch Spring	58	Firing Pin Spring (7.62 Only)
26	Hammer with Hammer Pin Retainer		
*Items on Parts List are reserved for qualified gunsmiths or the Authorized Product Center only			

EXPLODED VIEW



HUNTER MODELS

Parts List: Tactical Model			
Item No.	Description	Item No.	Description
1*	Lower Receiver	30	Firing Pin
2	Trigger	31	Firing Pin Retaining Pin
3	Trigger Pin	32	Cam Pin
4	Trigger Spring	33*	Bolt with Gas Rings
5	Disconnecter	34	Extractor Assembly
6	Disconnecter Spring	35	Extractor Pin
7	Safety Selector Lever	36	Ejector
8	Safety Detent	37	Ejector Pin
9	Safety Detent Spring	38	Ejector Spring
10	Takedown Pin	39	Charging Handle
11	Pivot Pin	40	Receiver Extension
12	Takedown/Pivot Pin Detents	41	Buffer Assembly
13	Takedown/Pivot Pin Detent Springs	42	Action Spring
14	Pistol Grip	43	Buttstock
15	Grip Screw	44	Receiver Extension Nut
16	Grip Lockwasher	45	Receiver End Plate
17	Grip Cap	46	Buffer Retainer
18	Trigger Guard Screw	47	Buffer Retainer Spring
19	Magazine Catch	48*	Upper Receiver Assembly
20	Magazine Release Button	49	Handguard, Picatinny
21	Magazine Release Button Spring	50	Magazine
22	Bolt Catch	51	Ejection Port Cover Assembly
23	Bolt Catch Pin	52	Ejection Cover Spring
24	Bolt Catch Plunger	53	Ejection Cover Hinge Pin
25	Bolt Catch Spring	54	Cover Hinge Pin Snap Ring
26	Hammer with Hammer Pin Retainer	55	Front Sight
27	Hammer Spring	56	Rear Sight
28	Hammer Pin	57	Handguard Screws
29*	Bolt Carrier with Bolt Carrier Key		

*Items on Parts List are reserved for qualified gunsmiths or the Authorized Product Center only

EXPLODED VIEW



TACTICAL MODEL

A large, empty rectangular box with a thin black border, occupying most of the page. It is intended for the user to write their notes.

A large, empty rectangular box with a thin black border, occupying most of the page. It is intended for the user to write their notes.

A large, empty rectangular box with a thin black border, occupying most of the page. It is intended for the user to write their notes.

FIREARMS SAFETY DEPENDS ON YOU. MAKE NO MISTAKE ABOUT IT!

From the time an individual picks up a firearm, that individual shooter becomes a part of a system over which he has complete control. He is the only part of the system that can make a gun safe – or unsafe. Hunting and target shooting are among the safest of all sports. This booklet is intended to make them even safer – by re-emphasizing and reaffirming the basics of safe gun handling and storage and by reminding each individual shooter that he or she is the key to firearms safety. You can help meet this responsibility by enrolling in hunter safety or shooting safety courses. You must constantly stress safety when handling firearms, especially to children and non-shooters. Newcomers in particular must be closely supervised when handling firearms with which they may not be acquainted. Don't be timid when it comes to gun safety. If you observe anyone violating any safety precautions, you have an obligation to suggest safer handling practices, such as those in this booklet. Please read these rules carefully and follow the safety procedures outlined. Firearms safety is up to you. Make no mistake about it.

- 1. ALWAYS KEEP THE MUZZLE POINTED IN A SAFE DIRECTION**
- 2. FIREARMS SHOULD BE UNLOADED WHEN NOT ACTUALLY IN USE**
- 3. DON'T RELY ON YOUR GUN'S "SAFETY"**
- 4. BE SURE OF YOUR TARGET AND WHAT'S BEYOND IT**
- 5. USE CORRECT AMMUNITION**
- 6. IF YOUR GUN FAILS TO FIRE WHEN THE TRIGGER IS PULLED, HANDLE WITH CARE**
- 7. ALWAYS WEAR EYE AND EAR PROTECTION WHEN SHOOTING**
- 8. BE SURE THE BARREL IS CLEAR OF OBSTRUCTIONS BEFORE SHOOTING**
- 9. DO NOT ALTER OR MODIFY YOUR GUN, AND HAVE GUNS SERVICED REGULARLY**
- 10. LEARN THE MECHANICAL AND HANDLING CHARACTERISTICS OF THE FIREARM YOU ARE USING**

*Courtesy of
Sporting Arms and Ammunition Manufacturers' Institute, Inc.*